



288-TM



MAXIMUM LIFTING CAPACITY: 36,000 lbs
EXTENDED LENGTH: 82.3'

The first 6 section boom on Boom Truck
Known World Wide, TADANO Quality in North America



TM-1882 (18 ton) crane specifications

MAXIMUM LIFTING CAPACITY

36,000 lbs. @ 5' (5-part lines)

BOOM

6-sectioned, fully powered partly synchronized telescoping boom of pentagonal box construction

Retracted length	18.4'
Extended length	82.4'
Extended speed	64.0' / 59 s
Elevation	Elevated by double-acting hydraulic cylinder
Elevation speed	-7° to 80° / 20 s

NOTE: Extended speed and elevation speed are calculated under the condition that the flow is 25 GPM

Boom point 2 sheaves

WINCH

Hydraulic motor driven, Planetary gear speed reduction, provided with automatic break

Single line pull	7,200 lbs.
	*9,700lbs (Winch capacity of permissible line pull at 1st layer)
Single line speed	280 FPM (@ 3rd layer)

NOTE: Single line speed is calculated under the condition that the flow is 57 GPM

Wire rope

diameter x length	9/16" x 279'
breaking strength	30,100 lbs.

Hook block

Swivel hook with safety latch for single line use
-7,000 lbs. capacity (Standard)
*Johnson Downhaul hook block weight; 162 lbs. with 7 tons capacity

SWING

Hydraulic motor driven, Planetary gear speed reduction

Non-Continuous 375° rotation on ball bearing slew ring (Standard)

Swing speed	375° / 38 s
-------------	-------------

Continuous 360° full circle swing (Optional)

Swing speed	360° / 37 s
-------------	-------------

OUTRIGGERS

<TRACTOR MOUNTED>

Outriggers (Out & Down type)

Hydraulically extended sliders and hydraulically extended jacks, integral with crane frame

Extend width	Min. 7.15'
	Mid. 13.1'
	Max. 18.7'

Rear stabilizers

Hydraulically extended jacks, Integral with chassis frame

Span	7.38'
------	-------

Single front stabilizer

Hydraulic extended jack in front of bumper for 360° lifting operations

<CAB BACK MOUNTED>

Outriggers (Out & Down type)

Hydraulically extended sliders and hydraulically extended jacks, integral with crane frame

Extend width	Min. 7.15'
	Mid. 13.1'
	Max. 18.7'

Rear stabilizers (Straight Down Type)

Hydraulically extended jacks, Integral with chassis frame

Span	7.38'
------	-------

Rear stabilizers (Out & Down type; Optional)

Hydraulically extended sliders and hydraulically extended jacks, integral with chassis frame

Extend width	Min. 7.38'
	Max. 11.48'

Single front stabilizer

Hydraulic extended jack in front of bumper for 360° lifting operations

<REAR MOUNTED>

Rear outriggers (Out & Down type)

Hydraulically extended sliders and hydraulically extended jacks, integral with crane frame

Extend width	Min. 7.15'
	Mid. 13.1'
	Max. 18.7'

Front outriggers (Out & Down type)

Hydraulically extended sliders and hydraulically extended jacks, integral with chassis frame

Extend width	Min. 7.15'
	Mid. 13.1'
	Max. 18.7'



TM-1882 (18 ton) crane capacity

WORKING RANGE

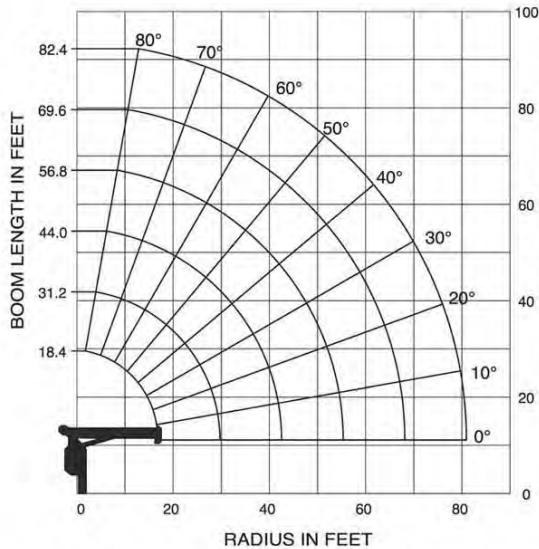

The above lifting heights and boom angles are based on a straight (unladen) boom, and allowance should be made for boom deflection obtained under laden condition.

NOTE:

- Rated lifting capacities on this chart show maximum allowable loads with outriggers properly extended on a firm surface and the crane leveled and mounted on a factory recommended truck. The rated lifting capacities in shaded areas are based on crane strength and others, on its stability (not to exceed 85% of tipping).
- The weight of handling devices such as hook block, slings, etc., must be considered part of the load and must be deducted from the rated lifting capacities.
- Weights of any accessories attached to the boom or loadline must be deducted from the rated lifting capacities.
- The operator must reduce loads to allow for such factors as wind, ground conditions, operating speed and the effects of freely suspended loads such as boom deflection.
- For full capacity 360° around the truck, the chassis requires the front stabilizer (ex. rear mounted) and additional counterweight in the underside of the bed.
- For boom lengths or radius not shown, use the rated lifting capacity of next longer boom lengths or radius.
- For boom lengths longer than 31.2 ft., extend outriggers to max. or mid.
- For boom lengths longer than 56.8 ft., extend outriggers to max.
- 56.8 ft. boom means 1st mark on 4th boom section side plate is half visible.
- 69.6 ft. boom means 2nd mark on 4th boom section side plate is half visible.
- Winch wire rope: diameter x length 9/16" x 279', breaking strength 30, 100 lbs.
- Keep at least 3 wraps of loadline on winch drum.
- Maximum load for number of part lines is as shown below.
- Part of lines are;

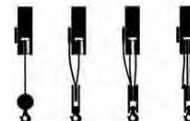

No. of part lines	1	2	4	5
Max. of load	7,200 lbs.	14,400 lbs.	28,800 lbs.	36,000 lbs.

RATED LIFTING CAPACITY (IN POUNDS)

Load radius (ft.)	18.4 ft. Boom			31.2 ft. Boom			44 ft. Boom		56.8 ft. Boom		69.6 ft. Boom		82.4 ft. Boom		Load radius (ft.)					
	Loaded Boom Angle	Outriggers Extended			Loaded Boom Angle	Outriggers Extended			Loaded Boom Angle	Outriggers Extended		Loaded Boom Angle	Outriggers Extended							
		Max.	Mid.	Min.		Max.	Mid.	Min.		Max.	Mid.		Max.	Mid.						
5	75°	36,000	30,000	22,000											5					
8	64°	23,000	23,000	15,200	76°	17,450	17,450	13,200							8					
10	57°	19,350	19,350	10,100	73°	17,450	17,450	8,750	79°	17,450	17,450				10					
12	48°	16,550	16,550	7,400	69°	15,600	15,600	6,350	76°	14,650	14,650				12					
14	38°	14,550	14,550	5,650	64°	13,650	13,650	4,800	73°	12,750	12,750				14					
16	24°	13,000	12,700	4,500	60°	12,300	11,600	3,750	70°	11,500	11,000				16					
20					51°	10,000	7,700	2,350	65°	9,400	7,700				20					
25					36°	8,100	4,950	1,300	57°	7,600	4,950				25					
30									48°	6,250	3,350				30					
35									38°	5,050	2,400				35					
40									23°	3,800	1,650				40					
45															45					
50															50					
55															55					
60															60					
65															65					
70															70					
75															75					
80															80					
	0°	8,400	8,400	4,050	0°	3,950	3,400	600	0°	1,850	1,300	0°	1,100	700	0°	600	0°	350		
		(16.89ft.)				(29.69ft.)				(42.48ft.)			(55.28ft.)			(68.07ft.)			(81.33ft.)	

Notice: The chart is only for reference and should not be used for operation. Maintain a clearances at least 10 feet between any part of the crane, load line or load and any electrical line carrying up to 50,000 volts. One foot additional clearance is required for every additional 30,000 volts or less.

<TRACTOR MOUNTED>

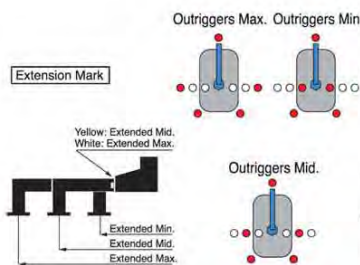

<CAB BACK MOUNTED>

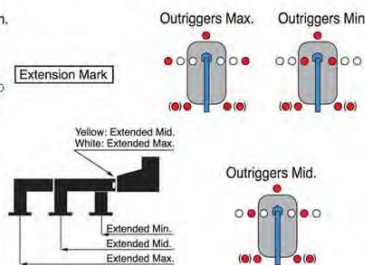

<REAR MOUNTED>

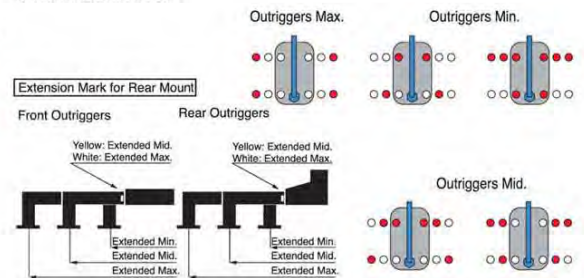



TM-1882 (18 ton) crane configurations

<TRACTOR MOUNTED>

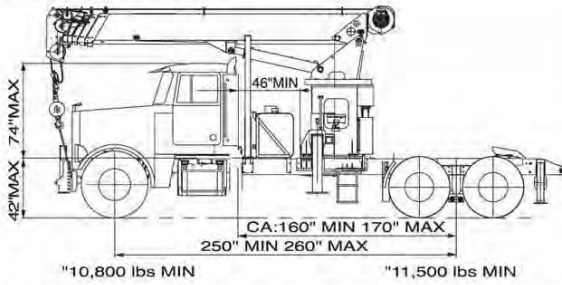

This mount requires front stabilizer, rear stabilizers, and additional counterweight in the underside of the tractor frame for full capacity 360° around the truck. The complete unit must be installed in accordance with factory requirements and a test performed to determine actual stability and counterweight requirements for variety of trucks.

<CAB BACK MOUNTED>

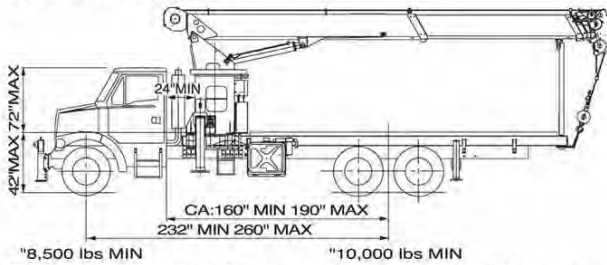

This mount requires front stabilizer, rear stabilizers torsion resisting box and additional counterweight in the underside of the bed for full capacity 360° around the truck. The complete unit must be installed in accordance with factory requirements and a test performed to determine actual stability and counterweight requirements for variety of trucks.

<REAR MOUNTED>

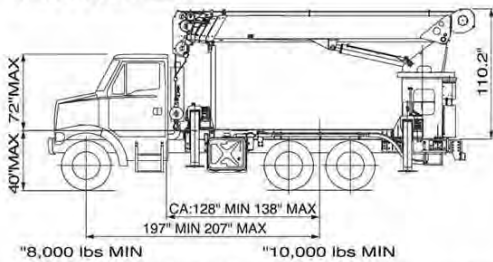

This mount requires front outriggers, torsion resisting box and additional counterweight in the underside of the bed for full capacity 360° around the truck. The complete unit must be installed in accordance with factory requirements and a test performed to determine actual stability and counterweight requirements since individual truck chassis vary.

Gross Axle Weight Rating(GAWR), front	approx. 20,000 lbs.
Gross Axle Weight Rating(GAWR), rear	approx. 34,000 lbs.
Gross Vehicle Weight Rating	approx. 54,000 lbs.
Wheelbase(WB)	250" to 260"
Cab to axle(CA)	160" to 170"
Stability weight, front	* 10,800 lbs. Min.
Stability weight, rear	* 11,500 lbs. Min.
Frame Section Module(SM) under crane, 110,000PSI steel	30 in ³ Min. per rail
Frame Section Module(SM) at the front stabilizer attachment point, 110,000PSI steel	2 in ³ Min. per rail
Frame Section Module(SM) over rear stabilizers, 110,000PSI steel	26 in ³ Min. per rail
PTO torque	approx. 290 ft-lbs Min.
PTO revolution	approx. 550 to 2,400 rpm
Width for crane mounting	approx. 4' 7" Min.
Frame width(outside)	approx. 3' Max.
Frame height(ground to frame top)	approx. 3' 6" Max.

* Estimated axle scale weights prior to installation of crane and stabilizers for 85% stability. Include fifth wheel and counterweight.

Gross Axle Weight Rating(GAWR), front	approx. 16,000 lbs.
Gross Axle Weight Rating(GAWR), rear	approx. 34,000 lbs.
Gross Vehicle Weight Rating	approx. 50,000 lbs.
Wheelbase(WB)	232" to 260"
Cab to axle	160" to 190"
Stability weight, front	* 8,500 lbs. Min.
Stability weight, rear	* 10,000 lbs. Min.
Frame Section Module(SM) under crane, 110,000PSI steel	20 in ³ Min. per rail (30 in ³ Min. per rail for low profile)
Frame Section Module(SM) at the front stabilizer attachment point, 110,000PSI steel	2 in ³ Min. per rail
Frame Section Module(SM) over rear stabilizers, 110,000PSI steel	13 in ³ Min. per rail (30 in ³ Min. per rail for low profile)
PTO torque	approx. 290 ft-lbs Min.
PTO revolution	approx. 550 to 2,400 rpm
Width for crane mounting	approx. 4' 7" Min.
Frame width(outside)	approx. 3' Max.
Frame height(ground to frame top)	approx. 3' 6" Max.

* Estimated axle scale weights prior to installation of crane, stabilizers and torsion box for 85% stability. Include counterweight.

Gross Axle Weight Rating(GAWR), front	approx. 14,000 lbs.
Gross Axle Weight Rating(GAWR), rear	approx. 34,000 lbs.
Gross Vehicle Weight Rating	approx. 48,000 lbs.
Wheelbase(WB)	197" to 207"
Cab to axle	128" to 138"
Stability weight, front	* 8,000 lbs. Min.
Stability weight, rear	* 10,000 lbs. Min.
Frame Section Module(SM) under crane, 110,000PSI steel	30 in ³ Min. per rail
Frame Section Module(SM) over rear outriggers, 110,000PSI steel	30 in ³ Min. per rail
PTO torque	approx. 290 ft-lbs Min.
PTO revolution	approx. 550 to 2,400 rpm
Width for crane mounting	approx. 4' 7" Min.
Frame width(outside)	approx. 3' Max.
Frame height(ground to frame top)	approx. 3' 4" Max.

* Estimated axle scale weights prior to installation of crane, stabilizers and torsion box for 85% stability. Include counterweight.

TM-1882 (18 ton) crane dimensional specifications

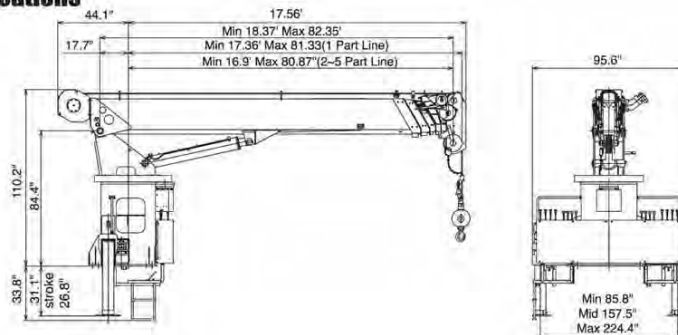



HYDRAULIC

Hydraulic motor	For winch and swing
Control valves	Multiple control valves with integral safety valve
Hydraulic pump	3-section gear pump Winch system : 32GPM (3,000PSI) Boom and outriggers system : 25GPM (3,060PSI) Swing system : 6.6GPM (1,750PSI)
Reserve tank	78 Gallons capacity *PTO/Mounting not included

ELECTRICAL SYSTEM

Power supply	DC12V
--------------	-------

SAFETY DEVICE

- Anti-two block with alarm
- Hook safety latch
- Level gauge
- Hydraulic safety valves, check valves and holding valves
- Overload shutoff with load indicator (TADANO's exclusive "AMA" system)
 - Load / Boom angle indication
 - Audible warning
 - External warning lamps

BOOM REST

- Removable

TORSION BOX

<TRACTOR MOUNTED>

The weight of standard torsion box is approx. 650 lbs. (8.5" height)

<CAB BACK MOUNTED>

The weight of 22' flat bed torsion box is approx. 4,000 lbs. (Optional)

<REAR MOUNTED>

The weight of 12' flat bed torsion box is approx. 2,150 lbs.(Not included front outriggers weight of 2,800 lbs)

CRANE WEIGHT

Approx. 12,800 lbs. (bare)

OPTIONS AND ACCESSORIES

+Radio Remote Controls

Model : RCS-F (Approved by FCC/IC)

Control function of boom telescoping, hoisting up and down, boom elevating, swing, acceleration, speed mode selection, emergency stop, engine start and vehicle horn

Frequency 40 frequencies in 429 MHz band

Operating power supply

Transmitter 6V DC, dry battery (AA) x 4

Control unit 12V DC, vehicle battery

Transmitter weight Approx. 1.26 lbs. (includes batteries)

**+Continuous 360° full circle swing**

Swing speed 360° / 37 s

+Short outriggers

For low profile mounting

+36,000 lbs. capacity hook block

2 sheaves, swivel type hook with safety latch (4 & 5 part line)

+14,400 lbs. capacity hook block

1 sheave, swivel type hook with safety latch (2 & 3 part line)

+Boom angle alarm**+Two person basket with radio remote for basket**

Introducing the TADANO TM-1882, the TADANO TM-1882 tractor mounted crane is also available in a straight truck mount behind the cab as well as rear mounted. TADANO has over 60 years of experience in manufacturing high quality cranes featuring innovative ideas and leading edge technology. The TM-1882 answers a real need for a true Boom Truck in North America. This is the crane that everyone has been looking for and we have delivered a crane packed with great features and superior performance.

With its long reach and high lift, we believe the TM-1882 is one of our most desirable cranes. TADANO builds a vast range of cranes from 0.5 ton to 600 tons. No matter what your reach or lift requirements are, TADANO can provide you with a great solution. Put one to work for you now. Call today or visit our web site for more information.

Features:

Exceptional Reach without a Jib: 82.4 ft. Full powered partly synchronized Boom

Self-Aligning Pentagonal Shaped Boom: reducing maintenance cost

Light Weight: increases payload

Out & Down Mainframe Outriggers: complete level ability

Multiple Outrigger Span: easy to set up in various job sites

Faster Function Speeds: increase productivity

Superior Winch Performance: up to 280 FPM increase productivity

Shear Plate Mounting: more secure "no creep mount"

Large Hydraulic Reservoir: superior cooling capabilities

Operator Friendly: dual control stations with exceptional job site viewing

Complete Load Monitoring: TADANO's exclusive "AMA" system



Highest Quality Boom Trucks on the Planet



TADANO AMERICA CORPORATION

4242 WEST GREENS ROAD
HOUSTON, TEXAS 77066 U.S.A.

PHONE: (281) 869-0030

FAX: (281) 869-0040

Parts Hotline: (281) 869-0033

Service Hotline: (281) 869-5925

Web site: <http://www.tadanoamerica.com>

E-mail: sales@tadano-cranes.com

