

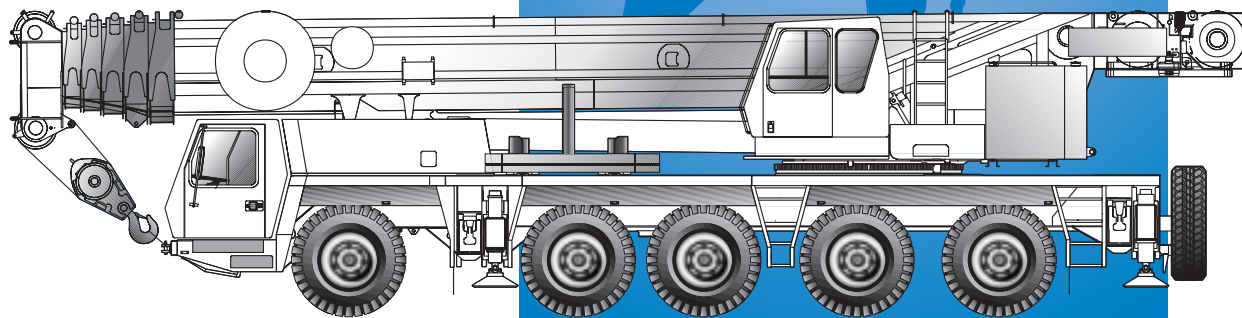

GMK 5210



All Terrain Hydraulic Crane



Dimensions

Cummins Version

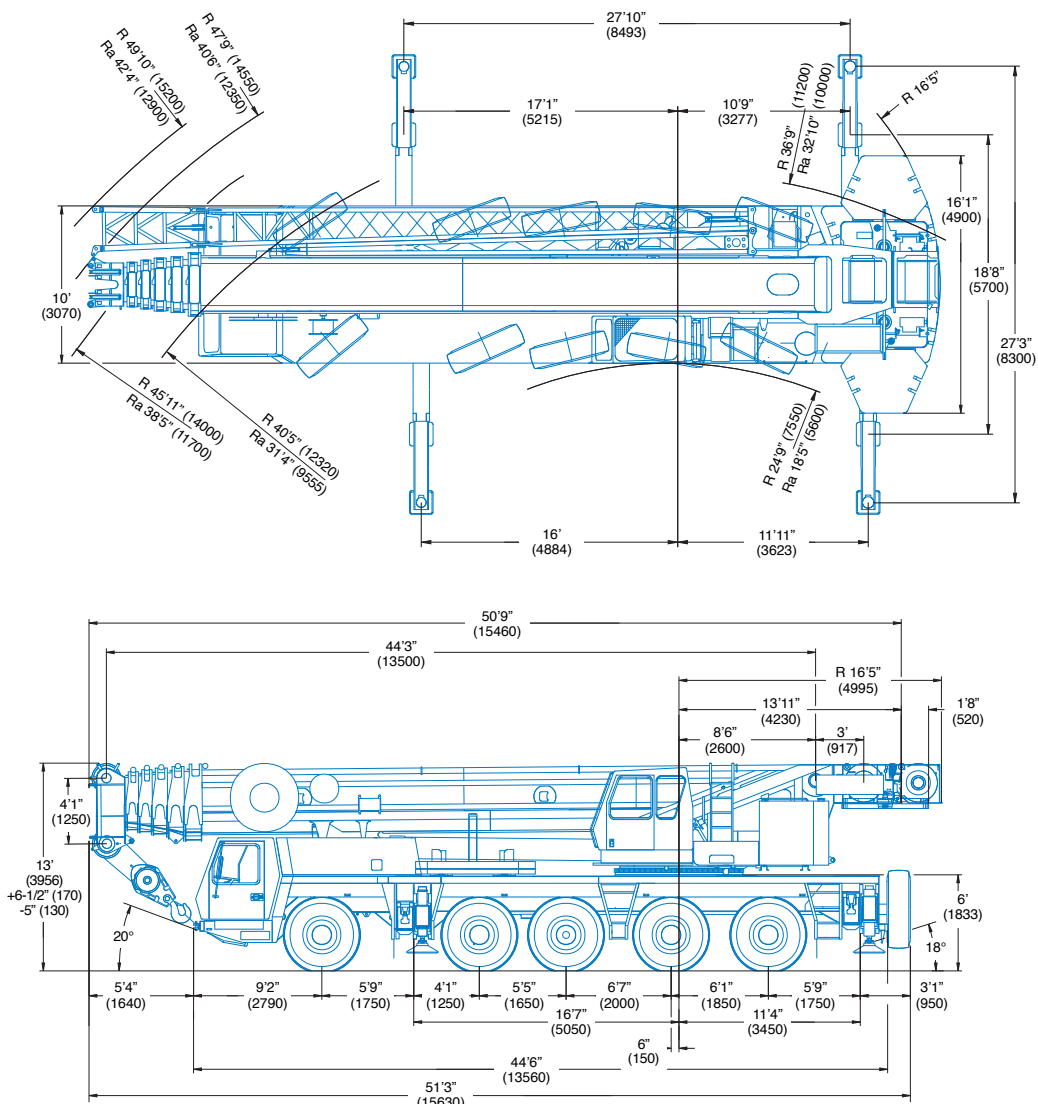

Note: () Reference dimensions in mm

BASIC WEIGHTS (LBS.)	Axles 1 - 3	Axles 4 & 5	Total
With Cummins Power, 10x8x10, 20.5 R25 Tires	82,480	52,060	134,540
With Mercedes Power, 10x8x10, 20.5 R25 Tires	80,544	53,115	133,659
Additions:			
Outrigger Pads	97	212	309
Auxiliary Hoist	-(3,340)	7,066	3,726
Brackets & Hydraulic Reeling Drum for Lattice Extension	934	-(273)	661
Lattice Extension - 43/72 ft	6,715	-(1,424)	5,291
Spare Tire - 14.00 R25 (including stowage bracket)	-(395)	979	584
Spare Tire - 16.00 R25 (including stowage bracket)	-(485)	1,202	717
Spare Tire - 20.5 R25 (including stowage bracket)	-(553)	1,362	809
Removal:			
Front Outrigger Beams & Jacks	-(5,315)	730	-(4,585)
Rear Outrigger Beams & Jacks	2,992	-(8,614)	-(5,622)
Boom Assembly (minus lift cylinder)*	-(41,678)	-(3,230)	-(44,908)
Lift Cylinder*	-(3,404)	-(1,071)	-(4,475)
10x6x10 in lieu of 10x8x10	-(159)	-(701)	-(860)
16.00 R25 Tires in lieu of 20.5	-(556)	-(370)	-(926)
14.00 R25 Tires in lieu of 20.5	-(1,349)	-(900)	-(2,249)

*Reflects weights with superstructure facing forward



Working range



44 - 197 ft.
(13.5 - 60 m)



138,800 lbs.
(63,000 kg)



100%



360°

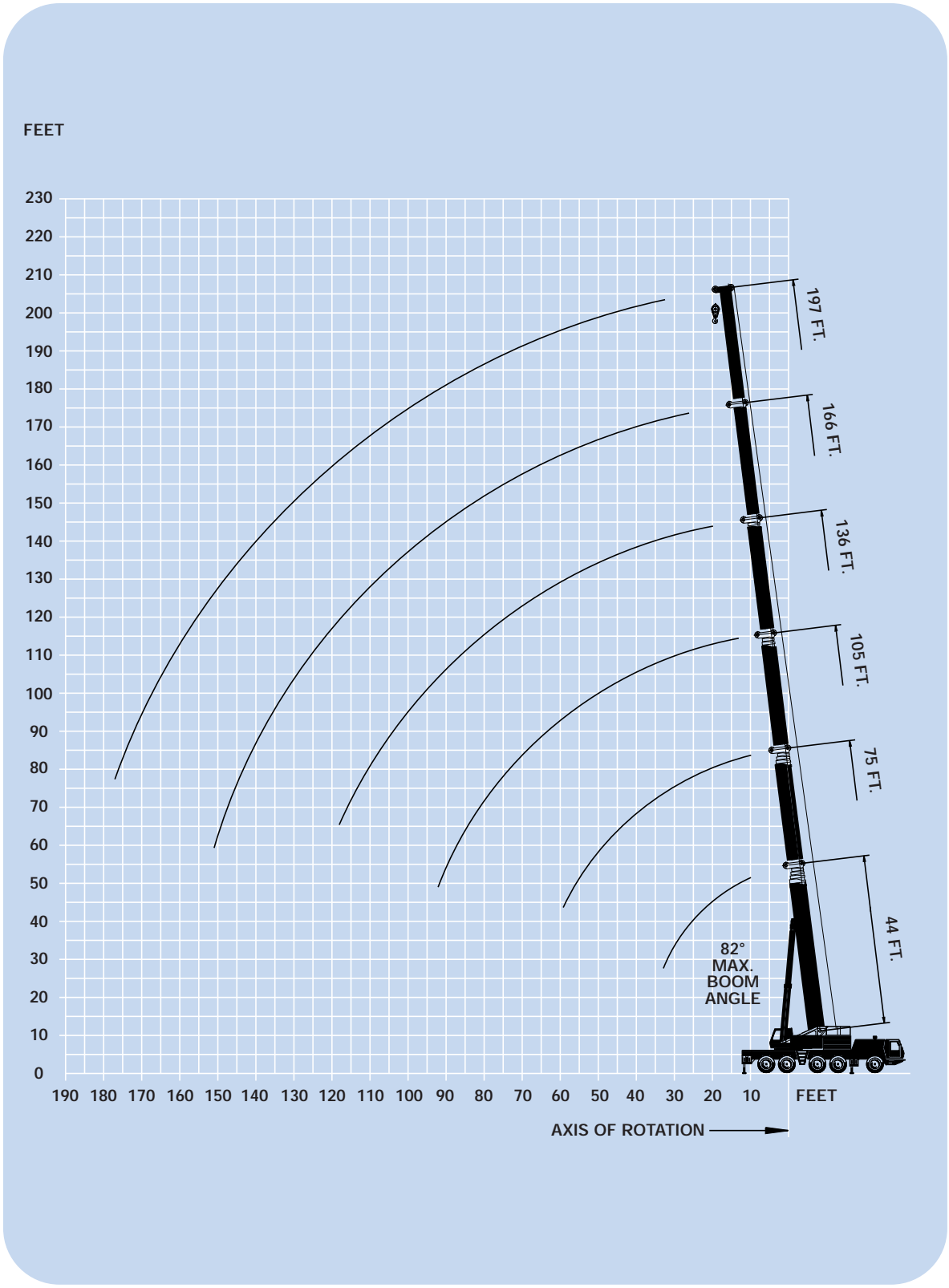

Superstructure specifications

Boom

44 ft. - 197 ft. (13.5 m - 60 m) six section, full-power boom with patented "twin-lock" boom pinning system. Maximum tip height: 207 ft. (63 m).

Boom Elevation

Single lift cylinder with safety valve provides boom angle from -1.5° to +82°.

Lattice Extension

43 ft. - 72 ft. (13 m - 22 m) lattice swingaway extension. Hydraulically offsettable 5° - 40° with hydraulic luffing.

*Optional Lattice Jib Extension

Two 26 ft. (8 m) inserts for use with lattice swingaway extension to increase length up to 98 ft. (30 m) or 125 ft. (38 m). Hydraulically offsettable 5° - 40° with hydraulic luffing.

Load Moment & Anti-Two Block System

Load moment and anti-two block system with audio/visual warning and control lever lockout provides electronic display of boom angle, length, radius, tip height, relative load moment, maximum permissible load, load indication and warning of impending two-block condition.

Cab

All aluminum construction cab is tiltable (approximately 20°) and includes safety glass and adjustable operator's seat with hydraulic suspension. Other features include engine dependent hot water heater, armrest integrated crane controls, and ergonomically arranged instrumentation.

Swing

3 swing gears with axial piston fixed displacement motors provide swing speed of 0 - 1.7 RPM thru planetary gear box. Also provided is a spring applied, hydraulically released automatic swing brake with foot-operated release for free swing.

Counterweight

138,800 lbs. (63 000 kg) consisting of various sections with hydraulic installation/removal system (see counterweight configuration on page 12).

Engine

Cummins 6BTA 5.9-C, diesel, 6 cylinders, water cooled, turbocharged, 165 HP (123 kW) at 2000 rpm. Max. torque: 538 ft./lbs. (730 Nm) at 1500 rpm. Engine emission: EUROMOT/EPA/CARB (off-highway).

Fuel Tank Capacity

53 gal. (200 L).

Hydraulic system

3 separate circuits, 2 axial piston variable displacement pumps, with electronic power limiting control and 1 axial piston variable displacement pump for swing. Standard thermostatically controlled oil cooler keeps oil at optimum operating temperature. Tank capacity: 259 gal. (980 L)

Control system

Full electronic control of all crane movements is accomplished using electrical control levers with automatic reset to zero. Controls are integrated with the LMI and engine management system by CAN-BUS.

Hoist

Main and auxiliary hoist are powered by axial piston variable displacement motor with planetary gear and brake. "Thumb-thumper" hoist drum rotation indicator alerts operator of hoist movement.

	<u>Main</u>	<u>Auxiliary</u>
Line length:	984 ft. (300 m)	755 ft. (230 m)
Rope diameter:	22 mm	22 mm
Line speed:	426 ft./min.	426 ft./min.
Line pull:	21,000 lbs. (93.4 kN)	21,000 lbs. (93.4 kN)

Electrical system

24 V system with three-phase alternator 28 V/80 A, 2 batteries 12 V/170 Ah.

*Optional equipment

- *Mercedes engine version
- *Engine-independent hot water heater, with engine pre-heater
- *Second spotlight
- *Stereo/cassette player
- *Air Conditioning

Carrier specifications

Chassis

Box-type, torsion resistant frame is fabricated from high-strength steel.

Outrigger System

Hydraulic two-stage outrigger beams are extended by a single hydraulic cylinder and two cables. Outriggers can adjust to two positions:

Fully extended (100%) - 27' 3" (8.3 m)

Partially extended (50%) - 18' 8" (5.7 m)

Four 23.6 in. (600 mm) square, self stowing, nylatron outrigger pads provide rigid lifting base. Outrigger controls are located on both sides of the carrier. An electronic level indicator is located next to each outrigger control box.

Engine

Cummins Signature 600, diesel, 6 cylinders, water cooled, turbo charged and aftercooled, 600 HP (448 kW) at 2000 rpm. Max. torque: 2,050 ft./lbs. (2780 Nm) at 1200-1400 rpm.

Engine emission: EUROMOT/EPA/CARB (on highway).

Fuel Tank Capacity

106 gal. (400 L).

Transmission

Allison automatic CLT 755, 5 forward and 1 reverse speed. Transfer case with 2 speeds and inter-axle differential lock.

Drive/Steer

10 x 8 x 10

Axles

1st axle line - drive/steer.

2nd axle line - drive/steer.

3rd axle line - steer.

4th axle line - steer (off road only)/drive.

5th axle line - drive/steer.

Drive axles with planetary hub reduction and center mounted gearing

Suspension

GMK5210 features the Grove exclusive MEGATRAK[†] suspension. This revolutionary design features an independent hydroneumatic system with hydraulic lockout acting on all wheels. The suspension can be raised 6-1/2" (170 mm) or lowered 5" (130 mm) both longitudinally and transversely and features an automatic leveling system for on-highway travel.

Tires

10 tires, 20.5 R25.

Steering

Dual circuit steering system is hydraulic power assisted with a transfer case mounted, ground driven, emergency steering pump. Axles 1, 2, 3 and 5 steer on highway. Separate steering of the 4th and 5th axle for all wheel steer and crab-steer is controlled by an electric rocker switch.

Brakes

A dual circuit air system operates on all wheels with a spring-applied, air released parking brake acting on axles 2, 3, 4 and 5. An air dryer is fitted to remove moisture from the air system.

Engine compression brake (Cummins) or exhaust brake and constant throttle brake (Mercedes) is standard.

Cab

Two-man, aluminum construction driver's cab with thru access, includes the following features: safety glass; driver and passenger seats with hydraulic suspension, engine-dependent hot water heater, complete instrumentation and driving controls.

Electrical system

24 V system with three-phase alternator 28 V/100 A, 2 batteries 12 V/170 Ah.

Maximum Speed

51 mph (82 km/h) with 20.5 R25 Tires

Gradeability (theoretical)

55% with 20.5 R25 Tires

Miscellaneous standard equipment

Boom removal kit; trailing boom kit (less dolly); additional hydraulic oil cooler; spare tire and wheel - 20.5 R25 with carry bracket; flashing amber warning light on carrier cab; working light; tool kit; fire extinguisher; rooster sheave; radio cassette in carrier cab.

*Optional equipment

*Mercedes engine version

*10 x 6 x 10

*Electric driveline retarder

*16.00 R25 (vehicle width 9 ft. 10 in. [3 m])

*14.00 R25 tires (vehicle width 9 ft. 10 in. [3 m])

*Outrigger pressure measurement devices

*Folding bunk bed in carrier cab

*Engine-independent hot water heater, with engine pre-heater

*Third seat



*Trailing boom "boost" weight transfer kit

*Air conditioning

*Denotes optional equipment



† "G MEGATRAK" (and design) is a trademark of Grove U.S. L.L.C.



 44 - 197 ft.
 (13.5 - 60.0 m)
  138,800 lbs.
 (63,000 kg)
  100%
 27' 3" Spread
  360°

Feet	Pounds (thousands)													
	44*	44	60	75	90	105	121	136	151	166	182	197		
9	420.0													
10	386.0	338.0		260.0	189.0									
15	308.0	262.0	264.0	258.0	189.0	153.0								
20	254.0	211.0	213.0	209.0	187.0	153.0	121.0	92.0						
25	210.0	176.0	178.0	175.0	174.0	150.0	121.0	87.0	68.0					
30	169.0	150.0	151.0	148.0	150.0	137.0	118.0	82.0	65.0	56.0	45.0			
35			131.0	128.0	130.0	123.0	109.0	76.0	63.0	54.0	44.0	38.8		
40			115.0	112.0	114.0	112.0	99.0	73.0	61.0	52.0	43.0	38.4		
45			103.0	99.0	101.0	102.0	90.0	66.0	59.0	50.0	42.2	37.4		
50				88.0	90.0	92.0	83.0	61.0	56.0	49.0	41.0	36.4		
55				78.0	80.0	82.0	77.0	57.0	51.0	47.0	39.8	35.4		
60					70.0	72.0	72.0	54.0	47.0	43.8	38.4	34.4		
65					65.0	63.0	66.0	51.0	42.4	40.0	36.8	33.4		
70					58.0	56.0	59.0	48.0	39.4	37.2	35.4	32.4		
75						52.0	52.0	45.0	36.4	34.4	33.2	31.4		
80							48.0	48.0	42.8	34.4	31.8	30.8	30.0	
85							45.0	43.4	41.0	33.0	30.0	28.6	28.0	
90								40.8	39.4	39.2	31.4	28.0	26.4	26.0
95									35.8	37.4	29.8	26.4	24.4	24.0
100									32.6	34.6	28.4	25.0	22.4	22.4
105										31.8	27.2	23.6	21.2	21.0
110										29.2	26.2	22.2	19.8	19.8
115										27.0	25.0	20.8	18.6	18.6
120											24.0	19.6	17.4	17.4
125											22.8	18.6	16.4	16.4
130											21.6	17.8	15.4	15.4
135											20.6	17.0	14.6	14.6
140												16.2	14.0	13.8
145												15.4	13.2	13.0
150												14.8	12.6	12.4
155													12.0	11.6
160													11.6	11.0
165														10.4
170														9.8
175														9.2
180														8.6

* Over rear only, 27'10" x 18'8" outrigger base.
Lifting capacities greater than 350,000 lbs (160,000 kg) require additional equipment.

 44 - 197 ft.
 (13.5 - 60.0 m)
  94,700 lbs.
 (43,000 kg)
  100%
 27' 3" Spread
  360°

Feet	Pounds (thousands)															
	44*	44	60	75	90	105	121	136	151	166	182	197				
9	420.0															
10	386.0	328.0	326.0	260.0	189.0											
15	308.0	254.0	256.0	252.0	189.0	153.0										
20	254.0	205.0	206.0	203.0	187.0	153.0	121.0	92.0								
25	196.0	171.0	172.0	169.0	171.0	150.0	121.0	87.0	68.0							
30	155.0	145.0	146.0	143.0	145.0	137.0	118.0	82.0	65.0	56.0	45.0					
35			126.0	122.0	124.0	122.0	109.0	76.0	63.0	54.0	44.0	38.8				
40			105.0	100.0	102.0	102.0	99.0	73.0	61.0	52.0	43.0	38.4				
45				87.0	82.0	88.0	87.0	88.0	66.0	59.0	50.0	42.2	37.4			
50					68.0	75.0	75.0	75.0	61.0	56.0	49.0	41.0	36.4			
55					62.0	66.0	66.0	65.0	57.0	51.0	47.0	39.8	35.4			
60						59.0	58.0	56.0	54.0	47.0	43.8	38.4	34.4			
65						52.0	51.0	50.0	51.0	42.4	40.0	36.8	33.4			
70						46.0	45.0	43.8	46.0	39.4	37.2	35.4	32.4			
75							41.2	40.4	41.2	40.8	36.4	34.4	33.2	31.4		
80								36.2	38.2	36.6	34.4	31.8	30.8	30.0		
85								33.2	34.6	33.0	33.0	30.0	28.6	28.0		
90									31.8	31.4	29.6	30.8	28.0	26.4	26.0	
95										28.4	27.2	27.8	26.4	24.4	24.0	
100											25.8	25.8	25.0	22.4	22.4	
105												24.6	23.0	20.4	21.0	
110													22.6	21.0	19.2	19.6
115														20.8	19.2	17.8
120															17.4	16.2
125															16.6	15.8
130															15.8	14.4
135															15.0	13.6
140																12.4
145																11.6
150																10.6
155																8.8
160																7.8
165																6.0
170																5.2
175																4.4
180																3.8

* Over rear only, 27'10" x 18'8" outrigger base.
Lifting capacities greater than 350,000 lbs (160,000 kg) require additional equipment.

THIS CHART IS ONLY A GUIDE AND SHOULD NOT BE USED TO OPERATE THE CRANE. The individual crane's load chart, operating instructions and other instructional plates must be read and understood prior to operating the crane.



44 - 197 ft.
 (13.5 - 60.0 m)
 47,300 lbs.
 (21,500 kg)
 100%
 27' 3" Spread
 360°

		Pounds (thousands)										
Feet	44	60	75	90	105	121	136	151	166	182	197	
10	316.0	316.0	260.0	189.0								
15	246.0	248.0	244.0	189.0	153.0							
20	197.0	199.0	196.0	187.0	153.0	121.0	92.0					
25	157.0	161.0	144.0	142.0	133.0	121.0	87.0	68.0				
30	117.0	122.0	109.0	112.0	110.0	102.0	82.0	65.0	56.0	45.0		
35		92.0	89.0	95.0	89.0	83.0	76.0	63.0	54.0	44.0	38.8	
40		75.0	77.0	78.0	74.0	69.0	69.0	61.0	52.0	43.0	38.4	
45		61.0	64.0	64.0	63.0	61.0	59.0	53.0	50.0	42.2	37.4	
50			53.0	54.0	53.0	55.0	51.0	50.0	45.0	41.0	36.4	
55			45.0	46.0	48.0	47.0	44.0	44.0	42.4	38.6	35.4	
60				39.4	41.6	40.6	40.6	38.8	38.0	36.2	33.8	
65				36.2	36.4	35.4	36.4	34.8	33.8	32.2	29.8	
70				32.0	32.2	32.4	32.2	32.2	30.6	28.6	26.4	
75				28.2	28.4	29.2	28.4	28.4	27.4	25.4	23.4	
80					25.2	26.0	25.8	25.2	24.2	22.8	20.8	
85					22.2	23.2	23.0	22.4	21.4	20.2	18.4	
90					19.8	20.8	20.6	20.0	19.0	18.0	16.2	
95						18.6	18.4	18.0	17.0	15.8	14.4	
100						16.8	16.6	16.0	15.0	14.0	12.6	
105							14.8	14.4	13.4	12.4	11.0	
110							13.4	12.8	11.8	10.8	9.6	
115							11.8	11.4	10.4	9.4	8.2	
120								10.2	9.2	8.2	7.0	
125								9.0	8.0	7.0	5.8	
130								7.8	7.0	6.0	4.8	
135								6.8	6.0	5.0	3.8	
140									5.0	4.0	3.0	
145									4.2	3.2		
150										3.4		

44 - 197 ft.
 (13.5 - 60.0 m)
 28,600 lbs.
 (13,000 kg)
 100%
 27' 3" Spread
 360°

		Pounds (thousands)										
Feet	44	60	75	90	105	121	136	151	166	182	197	
10	312.0	312.0	260.0	189.0								
15	242.0	244.0	240.0	189.0	153.0							
20	190.0	193.0	169.0	158.0	150.0	121.0	92.0					
25	142.0	139.0	119.0	121.0	118.0	108.0	87.0	68.0				
30	97.0	102.0	100.0	98.0	91.0	84.0	82.0	65.0	56.0	45.0		
35		79.0	81.0	79.0	74.0	73.0	68.0	61.0	54.0	44.0	38.8	
40		62.0	64.0	65.0	61.0	61.0	56.0	56.0	48.0	43.0	38.4	
45		50.0	52.0	53.0	55.0	52.0	51.0	47.0	46.0	41.0	37.4	
50			43.6	46.0	46.0	45.0	44.0	43.0	39.6	37.6	34.8	
55			37.4	39.4	39.4	39.8	38.6	37.4	35.0	32.4	29.8	
60				34.0	34.0	34.8	33.6	32.6	30.4	28.0	25.6	
65				29.4	29.4	30.2	29.4	28.6	26.6	24.4	22.0	
70				25.4	25.4	26.4	25.4	25.2	23.2	21.2	19.0	
75				22.0	22.0	23.0	22.0	22.2	20.4	18.4	16.4	
80					19.2	20.0	19.2	19.4	18.0	16.0	14.2	
85					16.6	17.6	16.8	16.8	15.8	14.0	12.0	
90					14.4	15.4	14.6	14.8	13.8	12.2	10.2	
95						13.6	12.8	12.8	11.8	10.4	8.6	
100						12.0	11.0	11.2	10.2	9.0	7.2	
105							9.6	9.8	8.8	7.6	5.8	
110							8.2	8.4	7.4	6.4	4.8	
115							7.0	7.2	6.2	5.2	3.6	
120								6.2	5.2	4.2	2.6	
125								5.2	4.2	3.2		
130								4.2	3.2			
135										3.4		

44 - 197 ft.
 (13.5 - 60.0 m)
 0 lbs.
 (0 kg)
 100%
 27' 3" Spread
 360°

		Pounds (thousands)										
Feet	44	60	75	90	105	121	136	151	166	182	197	
10	306.0	306.0	260.0	189.0								
15	232.0	208.0	164.0	155.0	141.0							
20	137.0	126.0	119.0	108.0	97.0	92.0	82.0					
25	93.0	91.0	87.0	80.0	78.0	70.0	67.0	59.0				
30	65.0	68.0	66.0	65.0	60.0	57.0	53.0	49.0	45.0	40.4		
35		52.0	52.0	51.0	48.0	46.0	43.0	39.8	36.2	32.6	29.0	
40		40.0	41.4	41.4	38.8	37.8	35.4	32.6	29.6	26.4	23.4	
45		30.4	33.8	34.2	32.0	31.4	29.4	27.2	24.4	21.6	18.6	
50			27.2	28.4	26.8	26.4	24.8	22.6	20.2	17.4	14.8	
55			21.8	24.0	22.4	22.2	20.8	18.8	16.6	14.0	11.6	
60				19.8	18.6	18.8	17.4	15.6	13.6	11.2	9.0	
65				16.4	15.6	15.8	14.6	13.0	11.0	8.8	6.8	
70				13.2	13.0	13.2	12.2	10.8	8.8	6.8	4.8	
75				10.8	10.8	11.2	10.2	8.8	7.0	5.0	3.2	
80					8.6	9.4	8.4	7.2	5.4	3.6		
85					6.8	7.8	6.8	5.6	4.0			
90					5.2	6.4	5.4	4.4	2.8			
95						5.0	4.2	3.2				
100						3.8	3.2					

THIS CHART IS ONLY A GUIDE AND SHOULD NOT BE USED TO OPERATE THE CRANE. The individual crane's load chart, operating instructions and other instructional plates must be read and understood prior to operating the crane.



Working Range



121 - 197 ft.
(36,8 - 60 m)



43 - 125 ft.
(13 - 38 m)



138,800 lbs.
(63,000 kg)



100%



360°

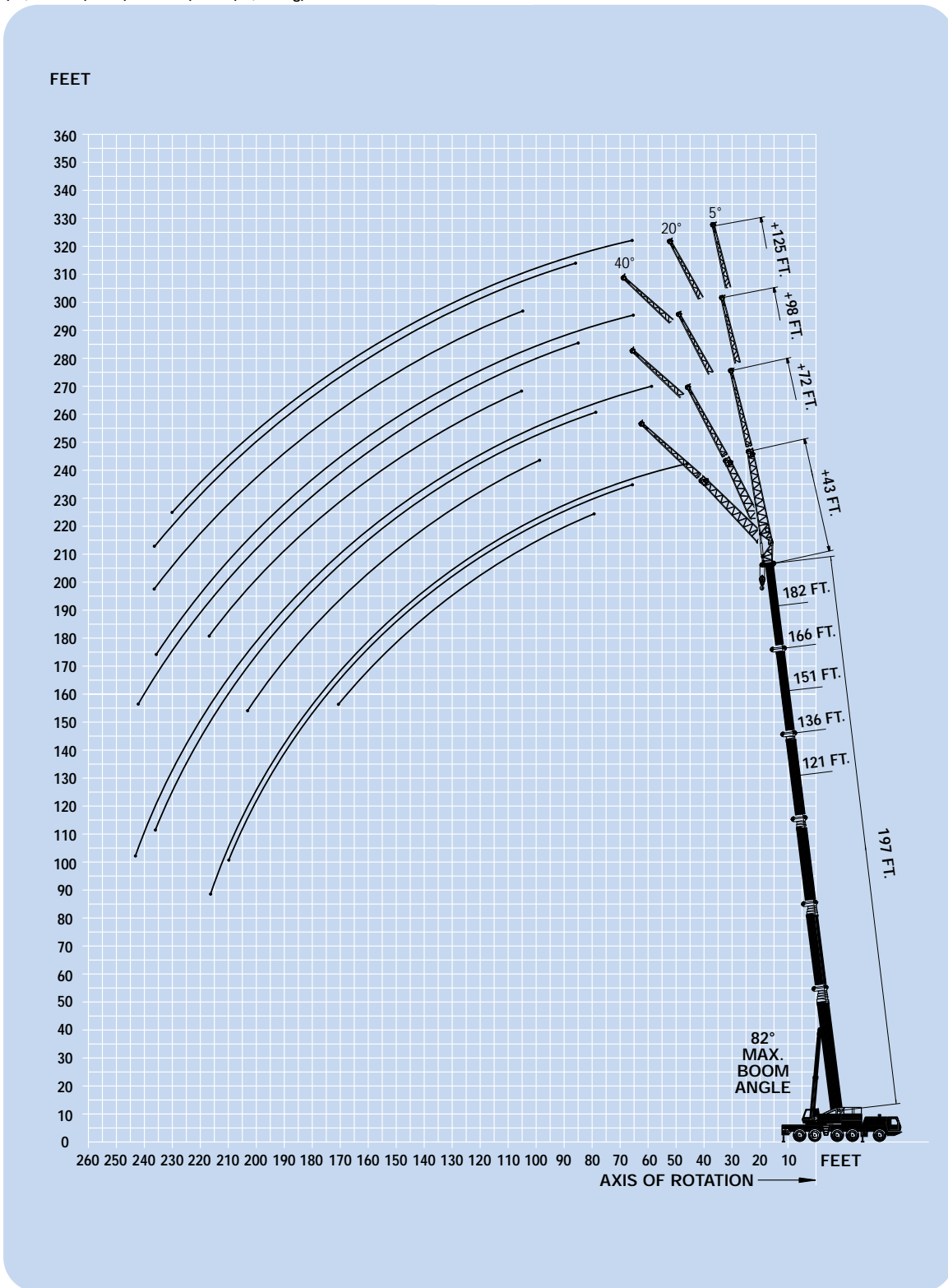



197 ft. (60.0 m)
 43-72-98-125 ft. (13-22-30-38 m)
 138,800 lbs. (63,000 kg)
 100% 27' 3" Spread
 360°

Feet	Pounds (thousands)											
	43 FT			72 FT			98 FT			125 FT		
	5°	20°	40°	5°	20°	40°	5°	20°	40°	5°	20°	40°
40	18.6											
45	18.6											
50	18.4											
55	18.4	18.6		12.2								
60	18.4	18.6		12.2			9.2			6.4		
65	18.2	18.4		12.2			9.2			6.4		
70	18.2	18.4	18.0	12.2			9.2			6.4		
75	18.2	18.4	18.0	12.2	11.0		9.2			6.4		
80	18.2	18.4	18.0	12.2	10.8		9.2			6.4		
85	18.0	18.2	18.0	12.2	10.8		9.2			6.4		
90	17.6	18.0	18.0	12.2	10.8		9.2	9.2		6.4	6.4	
95	17.4	17.8	18.0	12.0	10.6	10.0	9.2	9.2		6.4	6.4	
100	17.0	17.4	18.0	12.0	10.6	10.0	9.2	9.2	7.8	6.4	6.4	
105	16.6	17.0	17.4	12.0	10.6	10.0	9.2	9.2	7.8	6.4	6.4	6.4
110	16.2	16.6	16.6	11.8	10.4	10.0	9.2	9.2	7.8	6.4	6.4	6.4
115	15.6	15.8	16.0	11.8	10.4	9.8	9.2	9.0	7.8	6.4	6.4	6.4
120	14.6	15.0	15.2	11.6	10.4	9.8	9.2	8.8	7.8	6.4	6.4	6.4
125	13.8	14.0	14.4	11.6	10.4	9.8	9.2	8.6	7.8	6.4	6.2	6.2
130	13.0	13.2	13.8	11.6	10.4	9.6	9.2	8.6	7.8	6.4	6.2	6.2
135	12.4	12.6	13.0	11.4	10.2	9.6	9.0	8.4	7.8	6.4	6.0	6.0
140	11.6	12.0	12.4	11.0	10.2	9.6	8.8	8.2	7.8	6.2	6.0	5.8
145	11.0	11.2	11.8	10.4	10.0	9.4	8.6	8.0	7.6	6.2	5.8	5.8
150	10.4	10.6	11.0	10.0	9.8	9.4	8.4	8.0	7.6	6.0	5.8	5.6
155	9.6	10.0	10.4	9.4	9.6	9.4	8.0	7.8	7.4	5.8	5.6	5.6
160	9.0	9.4	9.8	9.0	9.2	9.2	7.8	7.6	7.4	5.8	5.4	5.4
165	8.4	8.8	9.2	8.6	9.0	9.2	7.6	7.4	7.2	5.6	5.4	5.2
170	8.0	8.2	8.6	8.0	8.6	8.8	7.2	7.2	7.0	5.4	5.2	5.2
175	7.4	7.8		7.6	8.0	8.4	6.8	6.8	6.8	5.2	5.2	5.0
180	7.0	7.2		7.2	7.6	8.0	6.6	6.6	6.8	5.0	5.0	5.0
185	6.6	6.8		6.8	7.2	7.6	6.2	6.4	6.6	5.0	5.0	4.8
190	6.0	6.2		6.2	6.8	7.2	5.8	6.0	6.4	4.8	4.8	4.8
195	5.6	5.8		5.8	6.4	7.0	5.4	5.8	6.2	4.6	4.6	4.6
200	5.2	5.4		5.4	6.0	6.4	5.0	5.4	6.0	4.4	4.4	4.6
205	4.8	5.0		5.0	5.6		4.8	5.2	5.6	4.0	4.2	4.4
210	4.4			4.8	5.2		4.4	4.8	5.2	3.8	4.0	4.2
215	4.0			4.4	4.8		4.0	4.4	4.8	3.4	3.8	4.0
220				4.0	4.4		3.6	4.0		3.2	3.6	3.8
225				3.6	4.0		3.4	3.6		2.8	3.2	3.6
230				3.2	3.6		3.0	3.4		2.6	3.0	3.4
235				3.0	3.2		2.6	3.0		2.4	2.8	3.2
240				2.6			2.4	2.8			2.4	
245				2.4				2.4				

197 ft. (60.0 m)
 43-72-98-125 ft. (13-22-30-38 m)
 138,800 lbs. (63,000 kg)
 100% 27' 3" Spread
 360°

Feet	Pounds (thousands)											
	43 FT		72 FT		98 FT		125 FT					
	5° - 20°	20° - 40°	5° - 20°	20° - 40°	5° - 20°	20° - 40°	5° - 20°	20° - 40°				
55	16.8											
60	16.8											
65	16.8											
70	16.8	16.4										
75	16.8	16.4	10.0									
80	16.8	16.4	9.8									
85	16.6	16.4	9.8									
90	16.4	16.4	9.8									
95	16.2	16.4	9.6	9.2								
100	15.8	16.2	9.6	9.0	8.4		5.8					
105	15.4	15.8	9.6	9.0	8.4	7.0	5.8					
110	15.0	15.2	9.6	9.0	8.4	7.0	5.8	5.8				
115	14.4	14.4	9.4	9.0	8.2	7.0	5.8	5.8				
120	13.6	13.8	9.4	9.0	8.0	7.0	5.8	5.8				
125	12.8	13.2	9.4	8.8	7.8	7.0	5.8	5.8				
130	12.0	12.4	9.4	8.8	7.8	7.0	5.6	5.6				
135	11.4	11.8	9.4	8.6	7.6	7.0	5.6	5.4				
140	10.8	11.2	9.4	8.6	7.4	7.0	5.4	5.4				
145	10.2	10.6	9.2	8.6	7.4	7.0	5.4	5.2				
150	9.6	10.0	9.0	8.6	7.2	6.8	5.2	5.2				
155	9.2	9.4	8.6	8.4	7.0	6.8	5.2	5.0				
160	8.6	8.8	8.4	8.4	7.0	6.6	5.0	5.0				
165	8.0	8.4	8.2	8.4	6.8	6.6	4.8	4.8				
170	7.6	7.8	7.8	8.0	6.6	6.4	4.8	4.8				
175	7.0		7.4	7.6	6.2	6.2	4.6	4.6				
180	6.6		7.0	7.4	6.0	6.2	4.6	4.6				
185	6.2		6.6	7.0	5.8	6.0	4.4	4.4				
190	5.6		6.2	6.6	5.6	5.8	4.4	4.4				
195	5.2		5.8	6.2	5.2	5.6	4.2	4.2				
200	4.8		5.4	5.8	5.0	5.4	4.0	4.2				
205	4.4		5.0		4.6	5.0	3.8	4.0				
210			4.6		4.4	4.8	3.6	3.8				
215			4.0		4.0	4.4	3.4	3.6				
220			4.0		3.6		3.2	3.4				
225			3.6		3.4		3.0	3.2				
230			3.2		3.0		2.8	3.2				
235			3.0		2.8		2.6	2.8				
240					2.4		2.2					

THIS CHART IS ONLY A GUIDE AND SHOULD NOT BE USED TO OPERATE THE CRANE. The individual crane's load chart, operating instructions and other instructional plates must be read and understood prior to operating the crane.



 197 ft. (60.0 m) 43-72-98-125 ft. (13-22-30-38 m) 94,700 lbs. (43,000 kg) 100% 27' 3" Spread 360°												
Pounds (thousands)												
Feet	43 FT			72 FT			98 FT			125 FT		
	5°	20°	40°	5°	20°	40°	5°	20°	40°	5°	20°	40°
40	18.6											
45	18.6											
50	18.4											
55	18.4	18.6		12.2								
60	18.4	18.6		12.2			9.2			6.4		
65	18.2	18.4		12.2			9.2			6.4		
70	18.2	18.4	18.0	12.2			9.2			6.4		
75	18.2	18.4	18.0	12.2	11.0		9.2			6.4		
80	18.2	18.4	18.0	12.2	10.8		9.2			6.4		
85	18.0	18.2	18.0	12.2	10.8		9.2			6.4		
90	17.6	18.0	18.0	12.2	10.8		9.2	9.2		6.4	6.4	
95	17.4	17.8	18.0	12.0	10.6	10.0	9.2	9.2		6.4	6.4	
100	17.0	17.4	18.0	12.0	10.6	10.0	9.2	9.2	7.8	6.4	6.4	
105	16.6	17.0	17.4	12.0	10.6	10.0	9.2	9.2	7.8	6.4	6.4	6.4
110	16.2	16.6	16.6	11.8	10.4	10.0	9.2	9.2	7.8	6.4	6.4	6.4
115	15.6	15.8	16.0	11.8	10.4	9.8	9.2	9.0	7.8	6.4	6.4	6.4
120	14.6	15.0	15.2	11.6	10.4	9.8	9.2	8.8	7.8	6.4	6.4	6.4
125	13.8	14.0	14.4	11.6	10.4	9.8	9.2	8.6	7.8	6.4	6.2	6.2
130	13.0	13.2	13.8	11.6	10.4	9.6	9.2	8.6	7.8	6.4	6.2	6.2
135	12.2	12.6	13.0	11.4	10.2	9.6	9.0	8.4	7.8	6.4	6.0	6.0
140	10.8	11.6	12.2	11.0	10.2	9.6	8.8	8.2	7.8	6.2	6.0	5.8
145	9.8	10.4	11.0	10.4	10.0	9.4	8.6	8.0	7.6	6.2	5.8	5.8
150	8.8	9.4	9.8	10.0	9.8	9.4	8.4	8.0	7.6	6.0	5.8	5.6
155	7.8	8.4	8.8	9.4	9.6	9.4	8.0	7.8	7.4	5.8	5.6	5.6
160	6.8	7.4	7.8	8.4	9.2	9.2	7.8	7.6	7.4	5.8	5.4	5.4
165	6.0	6.4	6.8	7.6	8.8	9.2	7.6	7.4	7.2	5.6	5.4	5.2
170	5.2	5.6	6.0	6.8	7.8	8.8	7.0	7.2	7.0	5.4	5.2	5.2
175	4.4	4.8		6.0	7.0	7.8	6.2	6.8	6.8	5.2	5.2	5.0
180	3.8	4.2		5.4	6.2	7.0	5.4	6.4	6.8	5.0	5.0	5.0
185	3.0	3.4		4.6	5.6	6.2	4.8	5.8	6.6	4.6	5.0	4.8
190	2.4	2.8		4.0	4.8	5.4	4.2	5.0	5.8	4.0	4.8	4.8
195				3.4	4.2	4.6	3.6	4.4	5.0	3.4	4.2	4.6
200				2.8	3.6	4.0	3.0	3.8	4.4	2.8	3.6	4.4
205				2.2	3.0		2.4	3.2	3.8	2.2	3.0	3.8
210					2.4			2.6	3.2		2.6	3.2
215									2.4			2.6

 197 ft. (60.0 m) 43-72-98-125 ft. (13-22-30-38 m) 94,700 lbs. (43,000 kg) 100% 27' 3" Spread 360°											
Pounds (thousands)											
Feet	43 FT		72 FT		98 FT		125 FT				
	5° - 20°	20° - 40°	5° - 20°	20° - 40°	5° - 20°	20° - 40°	5° - 20°	20° - 40°			
55	16.8										
60	16.8										
65	16.8										
70	16.8	16.4									
75	16.8	16.4		10.0							
80	16.8	16.4		9.8							
85	16.6	16.4		9.8							
90	16.4	16.4		9.8							
95	16.2	16.4		9.6	9.2						
100	15.8	16.2		9.6	9.0	8.4		5.8			
105	15.4	15.8		9.6	9.0	8.4	7.0	5.8			
110	15.0	15.2		9.6	9.0	8.4	7.0	5.8	5.8		
115	14.4	14.4		9.4	9.0	8.2	7.0	5.8	5.8		
120	13.6	13.8		9.4	9.0	8.0	7.0	5.8	5.8		
125	12.8	13.2		9.4	8.8	7.8	7.0	5.8	5.8		
130	12.0	12.4		9.4	8.8	7.8	7.0	5.6	5.6		
135	11.0	11.8		9.4	8.6	7.6	7.0	5.6	5.4		
140	10.0	10.6		9.4	8.6	7.4	7.0	5.4	5.4		
145	8.8	9.4		9.2	8.6	7.4	7.0	5.4	5.2		
150	8.0	8.6		9.0	8.6	7.2	6.8	5.2	5.2		
155	7.0	7.6		8.6	8.4	7.0	6.8	5.2	5.0		
160	6.2	6.8		7.8	8.4	7.0	6.6	5.0	5.0		
165	5.4	6.0		7.0	8.0	6.8	6.6	4.8	4.8		
170	4.8	5.2		6.2	7.2	6.4	6.4	4.8	4.8		
175	4.0			5.4	6.4	5.6	6.2	4.6	4.6		
180	3.4			4.8	5.6	5.0	5.8	4.6	4.6		
185	2.8			4.2	5.0	4.4	5.2	4.2	4.4		
190	2.2			3.6	4.4	3.8	4.6	3.6	4.4		
195				3.2	3.8	3.2	4.0	3.0	3.8		
200				2.6	3.2	2.6	3.4	2.6	3.4		
205						2.2	2.8		2.8		
210							2.4		2.4		

THIS CHART IS ONLY A GUIDE AND SHOULD NOT BE USED TO OPERATE THE CRANE. The individual crane's load chart, operating instructions and other instructional plates must be read and understood prior to operating the crane.



197 ft.
(60.0 m)

43-72-98-125 ft.
(13-22-30-38 m)

47,300 lbs.
(21,500 kg)

100%
27' 3" Spread

360°

Feet	Pounds (thousands)											
	43 FT			72 FT			98 FT			125 FT		
	5°	20°	40°	5°	20°	40°	5°	20°	40°	5°	20°	40°
40	18.6											
45	18.6											
50	18.4											
55	18.4	18.6		12.2								
60	18.4	18.6		12.2			9.2			6.4		
65	18.2	18.4		12.2			9.2			6.4		
70	18.2	18.4	18.0	12.2			9.2			6.4		
75	18.2	18.4	18.0	12.2	11.0		9.2			6.4		
80	18.2	18.4	18.0	12.2	10.8		9.2			6.4		
85	17.6	18.2	18.0	12.2	10.8		9.2			6.4		
90	15.6	17.0	18.0	12.2	10.8		9.2	9.2		6.4	6.4	
95	13.8	15.0	16.6	12.0	10.6	10.0	9.2	9.2		6.4	6.4	
100	12.0	13.4	14.6	12.0	10.6	10.0	9.2	9.2	7.8	6.4	6.4	
105	10.4	11.8	13.0	12.0	10.6	10.0	9.2	9.2	7.8	6.4	6.4	6.4
110	9.0	10.2	11.4	10.6	10.4	10.0	9.2	9.2	7.8	6.4	6.4	6.4
115	7.8	8.8	9.8	9.2	10.4	9.8	9.0	9.0	7.8	6.4	6.4	6.4
120	6.6	7.6	8.6	8.2	10.0	9.8	7.8	8.8	7.8	6.4	6.4	6.4
125	5.6	6.4	7.2	7.0	8.8	9.8	6.8	8.6	7.8	6.4	6.2	6.2
130	4.6	5.4	6.2	6.0	7.8	9.6	5.8	7.6	7.8	5.4	6.2	6.2
135	3.6	4.4	5.0	5.0	6.8	8.4	5.0	6.6	7.4	4.6	6.0	6.0
140	2.6	3.4	4.0	4.2	5.8	7.4	4.0	5.6	7.4	3.8	5.4	5.8
145		2.6	3.2	3.4	4.8	6.4	3.2	4.8	6.4	3.0	4.4	5.8
150			2.2	2.6	4.0	5.4	2.6	4.0	5.4	2.2	3.6	5.2
155					3.2	4.4		3.2	4.6		3.0	4.4
160					2.4	3.6		2.4	3.6		2.2	3.6
165						2.8			3.0			2.8
170									2.2			

197 ft.
(60.0 m)

43-72-98-125 ft.
(13-22-30-38 m)

47,300 lbs.
(21,500 kg)

100%
27' 3" Spread

360°

Feet	Pounds (thousands)							
	43 FT		72 FT		98 FT		125 FT	
	5° - 20°	20° - 40°	5° - 20°	20° - 40°	5° - 20°	20° - 40°	5° - 20°	20° - 40°
55	16.8							
60	16.8							
65	16.8							
70	16.8	16.4						
75	16.8	16.4	10.0					
80	16.8	16.4	9.8					
85	16.0	16.4	9.8					
90	14.2	15.4	9.8					
95	12.4	13.8	9.6	9.2	8.4		5.8	
100	11.0	12.2	9.6	9.0	8.4	7.0	5.8	
105	9.6	10.6	9.6	9.0	8.4	7.0	5.8	5.8
110	8.2	9.2	9.6	9.0	8.4	7.0	5.8	5.8
115	7.0	8.0	8.4	9.0	8.2	7.0	5.8	5.8
120	6.0	7.0	7.4	9.0	7.2	7.0	5.8	5.8
125	5.0	5.8	6.4	8.0	6.2	7.0	5.8	5.8
130	4.0	4.8	5.4	7.0	5.4	6.8	5.0	5.6
135	3.2	4.0	4.6	6.0	4.4	6.0	4.2	5.4
140	2.4	3.2	3.8	5.2	3.6	5.2	3.4	4.8
145		2.4	3.0	4.4	3.0	4.4	2.6	4.0
150			2.4	3.6	2.2	3.6		3.4
155				3.0		2.8		2.6
160				2.2		2.2		

THIS CHART IS ONLY A GUIDE AND SHOULD NOT BE USED TO OPERATE THE CRANE. The individual crane's load chart, operating instructions and other instructional plates must be read and understood prior to operating the crane.

Boom extension configurations

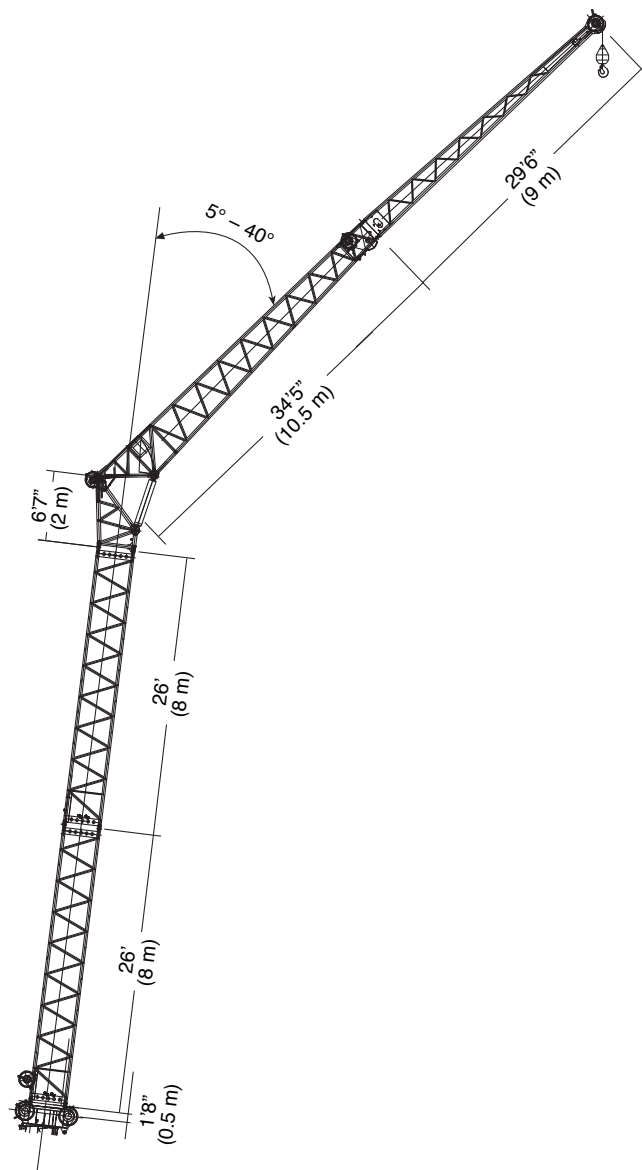

Length (ft.)	Intermediate section boom extension make-up			
	26' (8 m)	6'7" (2 m)	34'5" (10.5 m)	29'6" (9 m)
43	—	1x	1x	—
72	—	1x	1x	1x
98	1x	1x	1x	1x
125	2x	1x	1x	1x

Counterweight configurations

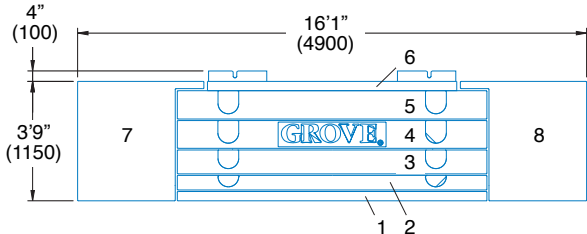

1. 9,700 lbs. (4,400 kg)

2. 11,200 lbs. (5,100 kg)

3. 18,700 lbs. (8,500 kg)

4. 24,300 lbs. (11,000 kg)

5. 23,100 lbs. (10,500 kg)

6. 7,700 lbs. (3,500 kg)

7. 22,050 lbs. (10,000 kg)

8. 22,050 lbs. (10,000 kg)

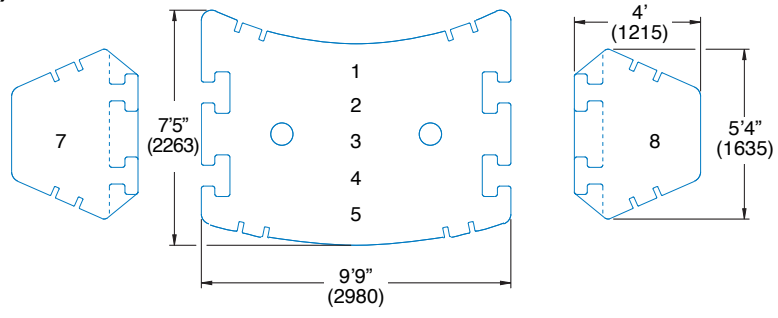
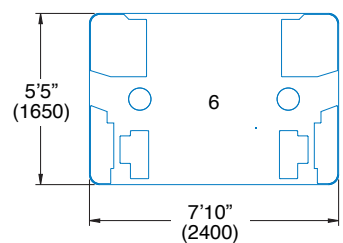
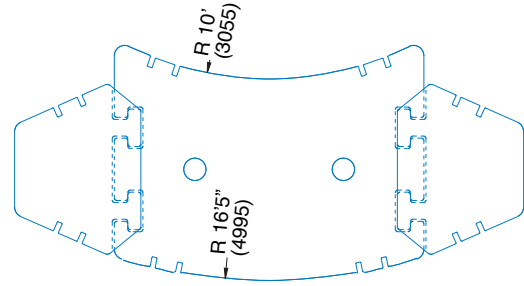

Note: () Reference dimensions in mm

	1	2	3	4	5	6	7	8
20,900 lbs.	X	X						
28,600 lbs.	X	X				X		
47,300 lbs.	X	X	X			X		
71,600 lbs.	X	X	X	X		X		
94,700 lbs.	X	X	X	X	X	X		
138,800 lbs.	X	X	X	X	X	X	X	X













Rated Lifting Capacities

IMPORTANT NOTES:

WARNING: THIS CHART IS ONLY A GUIDE. The notes below are for illustration only and should not be relied upon to operate the crane. The individual crane's load chart, operating instructions and other instruction plates must be read and understood prior to operating the crane.

1. All rated loads meet ANSI/ASME B30.5, Mobile and Locomotive Cranes. Testing and development were performed to SAEJ1063, Cantilevered Boom Crane Structures - Method of Test and SAEJ765 Crane Stability Test Code.
2. Capacities given do not include the weight of hook blocks, slings, auxiliary lifting equipment and load handling devices. Their weights must be added to the load to be lifted. When more than minimum required reeving is used, the additional rope weight shall be considered part of the load.
3. The machine shall be leveled on a firm supporting surface. Depending on the nature of the supporting surface, it may be necessary to have structural supports under the outrigger floats to spread the load to a larger bearing surface.
4. When either boom length or radius or both are between values listed, the smallest load shown at either the next larger radius or next longer or shorter boom length shall be used.
5. For outrigger operation, outriggers shall be properly extended with tires raised off the ground before operating the boom or lifting loads.

Symbols Glossary

	Frame		Steering
	Outriggers		Transmission
	Outrigger Controls		Axles
	Engine		Brakes
	Fuel Tank Capacity		Tires
	Electrical System		Suspension
	Drive		Rotation
	Lights		Boom Elevation
	Cab		Swing
	Boom		Counterweight
	Fixed Swingaway		Oil
	Tele-Swingaway		Hydraulic System
	Lattice Extension (Luffing)		Hoist
	Boom Nose		Radius
	Boom Extension		Boom Length
	Speed		Hookblock
	Grade		Gear
	Lattice Extension		Luffing Jib



Notes



Notes



Notes

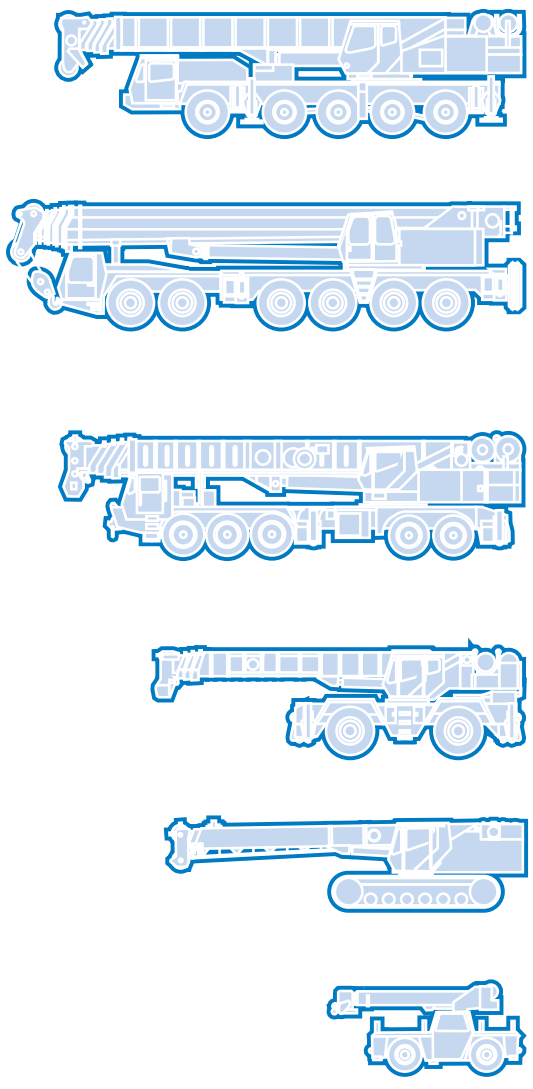

Grove Worldwide – World Headquarters
Grove U.S. L.L.C.
1565 Buchanan Trail East
P.O. Box 21
Shady Grove, Pennsylvania 17256, U.S.A.
Tel: [Int + 1] (717) 597-8121
Fax: [Int + 1] (717) 597-4062
Western Hemisphere, Asia/Pacific

Grove Europe Limited*
Sunderland SR4 6TT, England
Tel: [Int + 44] 191 565-6281
Fax: [Int + 44] 191 564-0442
Europe, Africa, Middle East

Grove Europe Limited*
Telford Road, Bicester
Oxfordshire, OX6 0TZ
Tel: [Int + 44] 1869 878-890
Fax: [Int + 44] 1869 878-891
*Grove Europe Limited, Registered in England,
Number 1845128, Registered office, Crown Works,
Pallion, Sunderland, Tyne & Wear, England SR4 6TT

Deutsche Grove GmbH
Sales and Service
Helmholtzstrasse 12, Postfach 5026
D-40750 Langenfeld, Germany
Tel: [Int + 49] (2173) 8909-0
Fax: [Int + 49] (2173) 8909-30

Wilhelmshaven Works
Industriegelände West, Postfach 1853
D-26358 Wilhelmshaven, Germany
Tel: [Int + 49] (4421) 294-0
Fax: [Int + 49] (4421) 294-301

Grove France S.A.
16, chaussée Jules-César, 95520 OSNY
B.P. 203, 95523 CERGY PONTOISE CEDEX
France
Tel: [Int + 33] (1) 30313150
Fax: [Int + 33] (1) 30386085

Grove Asia/Pacific – Regional Office
171 Chin Swee Road
#10-09 San Centre
Singapore 16987
Tel: [Int + 65] 536-6112
Fax: [Int + 65] 536-6119
Asia/Pacific, Near East

Grove China - Representative Office
Room 713, Towercrest Plaza
No. 3 Mai Zi Dian West Road
Chao Yang District
Beijing, China 100016
Tel: [Int + 86] (10) 64 67 16 90
Fax: [Int + 86] (10) 64 67 16 91

Grove Lifetime Customer Support
Western Hemisphere, Asia/Pacific
1086 Wayne Avenue
Chambersburg, Pennsylvania USA
Tel: [Int + 1] (717) 263-5100
Fax: [Int + 1] (717) 267-0404

Europe, Africa, Middle East
Sunderland SR4 6TT, England
Tel: [Int + 44] 191 565-6281
Parts Fax: [Int + 44] 191 515-7475
Service Fax: [Int + 44] 191 515-7340

<http://www.groveworldwide.com>

Bigge Crane and Rigging Co.
10700 Bigge Avenue
San Leandro, CA 94577
Phone: (888) 337-BIGGE or (510) 638-8100
Fax: (510) 639-4053
Email: info@bigge.com
Web site: www.bigge.com

Constant improvement and engineering progress make it necessary that we reserve the right to make specification, equipment, and price changes without notice. Illustrations shown may include optional equipment and accessories and may not include all standard equipment.

Distributed By:

